

microsystem



It is the smallest-of-the-range system solution based on an aluminium profile.

In the surface mounted version, the height is only 10.5 mm, while in the recessed version, it is the thickness of the gypsum board, thus giving the possibility of installation in interiors where a standard lowering of the ceiling is not possible. The modules that complete the system are also small in size: 3 spotlights and 1 pendant fixture with high luminous parameters (up to 600 lm from one fixture) ensuring high comfort of use.

The DALI system and the integrated 48V converter for each fixture offer the possibility to design lighting scenes tailored to individual needs, also by controlling each fixture separately.



track nt + AD 48V flato



track wp + AD 48V shift micro



track wp + AD 48V stik 16.200 zw



track nt + AD 48V stik pure 16







KAMA MUCHA

microsystem



AD 48V silk pure 16

microsystem

microsystem

Microsystem—profiles

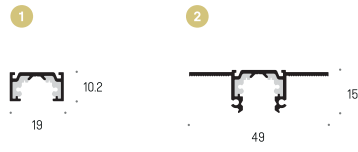

Microsystem—mechanical components

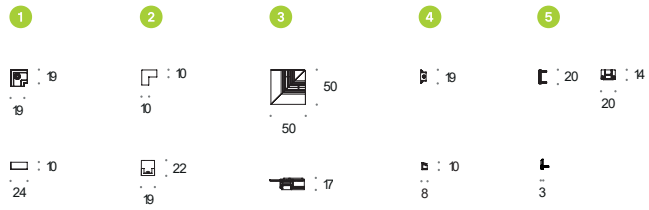

Microsystem—electrical components

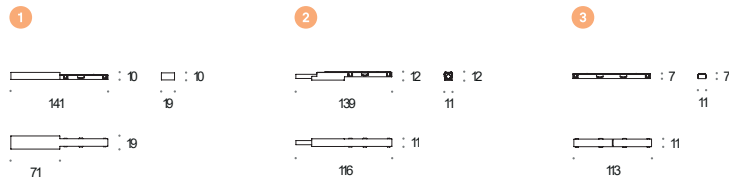

Microsystem—electrical components

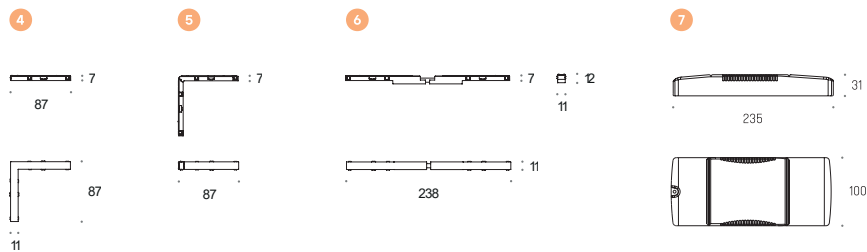

Microsystem—luminaires

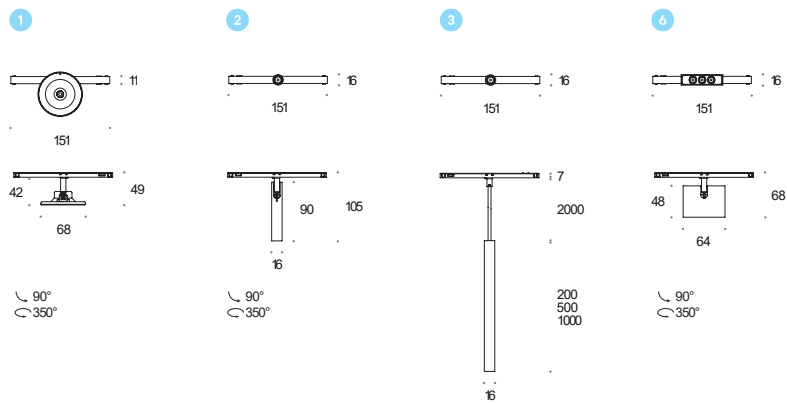

Model	Main Components	DALI2	Black	White	Mixed	CR88-2700K	CR88-3000K	CR88-4000K
			.02	.03	.99	.927	.930	.940
Microsystem48V —Profiles								
1	Track NT 100cm (surface)	7.2900	●	●				
1	Track NT 200cm(surface)	7.2901	●	●				
2	Track WP100cm (recessed)	7.2902	●					
2	Track WP200cm (recessed)	7.2903	●					
Microsystem48V —mechanical componenets								
1	mechanical Comer joint 90 Horizontal NT	7.2912	•	•				
2	mechanical Comer joint 90 Vertical NT	7.2913	•	•				
3	mechanical Comer joint 90 Horizontal WP	7.1883	•					
4	mechanical End cap NT	7.2911	•	•				
5	mechanical End cap WP	7.1884	•					
Microsystem48V —electrical components								
1	electrical End FeedNT	7.2906	•					
2	electrical End FeedWP	7.2907	•					
3	electrical Linear connector NT/WP	7.2908	•					
4	electrical Comer connector 90 horizontal NT/WP	7.2909	•					
5	electrical Comer connector 90 vertical NT/WP	7.2910	•					
6	electrical Comer connector adjustable NT/WP	7.1885	•					
7	48V Driver 75WNT/WP	9.1877						
7	48V Driver 150WNT/WP	9.1878						
Microsystem48V —Luminaires								
1	AD 48V Flato 7.4W600lm,46°	7.3667	•	•	•	•	•	•
2	AD 48V Stik Pure 16 5.6W240lm,42°	7.3668	•	•	•	●	●	
3	AD 48V Stik 16.200 ZW 7.6W310lm, 42°	7.3669	•	•	•	●	●	
3	AD 48V Stik 16.500 ZW 7.6W310lm, 42°	7.3670	•	•	•	●	●	
3	AD 48V Stik 16.1000 ZW 7.6W310lm, 42°	7.3671	•	•	•	●	●	
4	AD 48V Shift Micro 3x1 7.8W530lm,42°	7.3672	•	•	•	●	●	●

- .02 — Black Anode
- .02 — Black fine structure RAL9005
- .03 — White fine structure RAL9016
- CR80

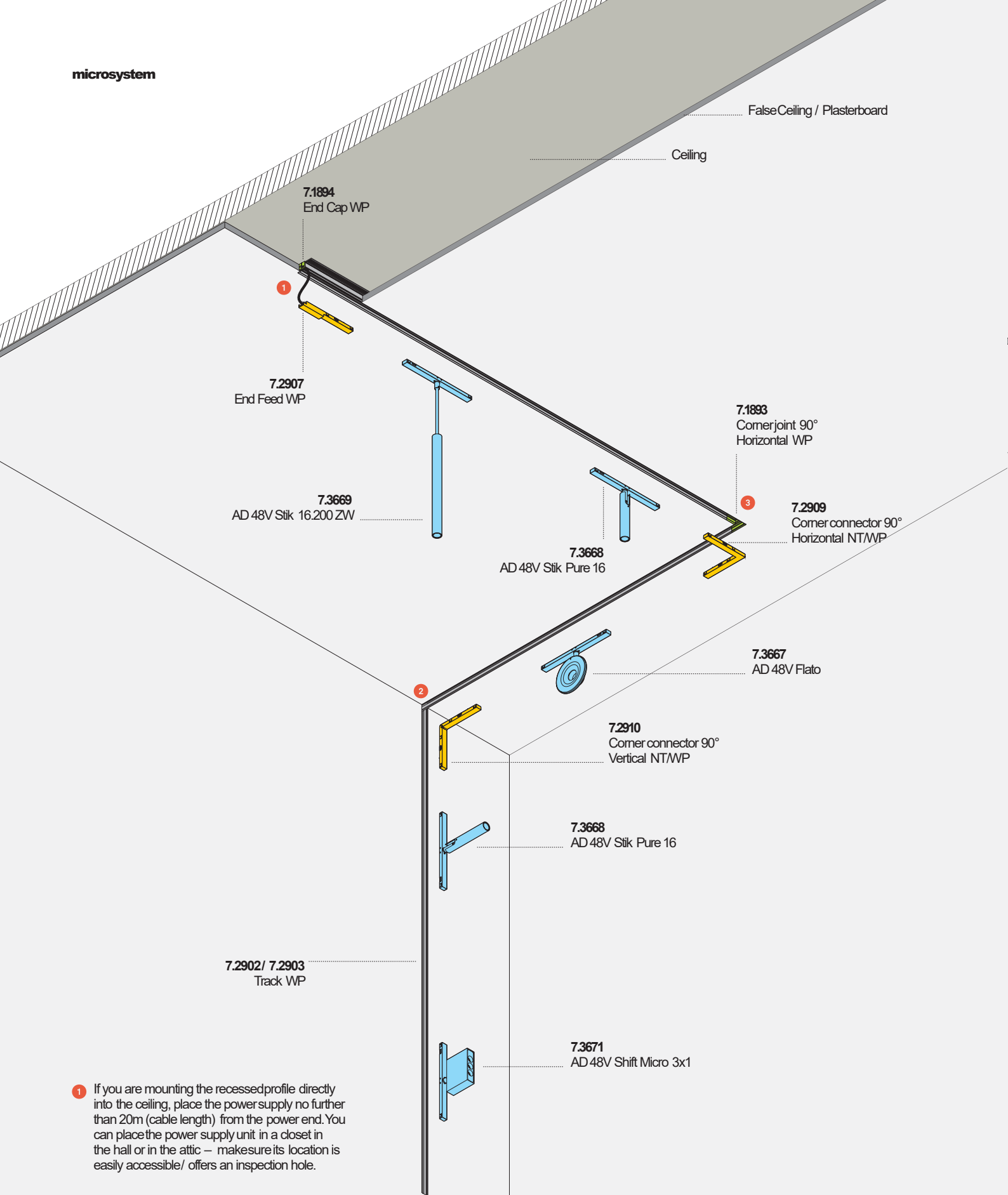

- 1 If you are mounting the recessed profile directly into the ceiling, place the power supply no further than 20m (cable length) from the power end. You can place the power supply unit in a closet in the hall or in the attic – make sure its location is easily accessible/ offers an inspection hole.
- 2 The ceiling-to-wall angle joint is created by butt jointing two WP profiles together. No additional mechanical coupling is required.
- 3 The WPhorizontal angle joint requires a suitable element. Also keep in mind that the mounting hole will need to be larger than the visible dimension of the profile once it is finally installed. Make sure to read the installation instructions.

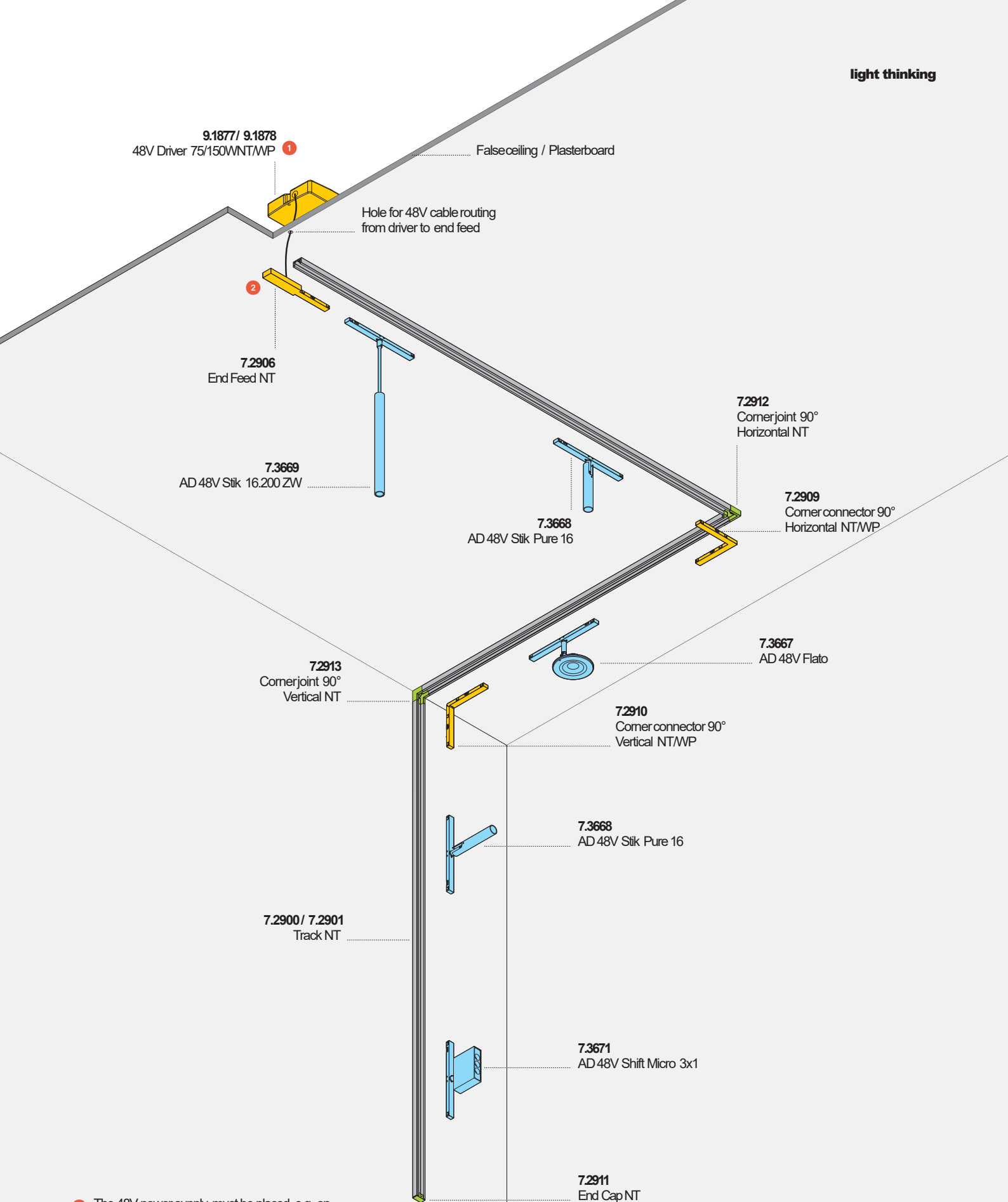

- 1 The 48V power supply must be placed, e.g., on the ceiling, or possibly in a closet in the adjacent room. Remember to place it close to the inspection opening.
- 2 The power end goes directly into the rail only halfway. The other half projects beyond the profile and is an extension of it. Keep this in mind when planning your system.

Alternative recessed mounting

- 1 The Microsystem WP profile can also be installed in the classic manner, on a standard structure using plasterboard – on condition, of course, that there is sufficient height between the ceiling and the suspended ceiling. In this option, the WP profile is screwed to the steel frame.
- 2 The power supply can be placed right next to the recessed profile or at a distance, but always make sure there is adequate access to it.
- 3 The other (mechanical and electrical) components of the system are used in exactly the same way as when mounting the profile directly on the ceiling (page 106).

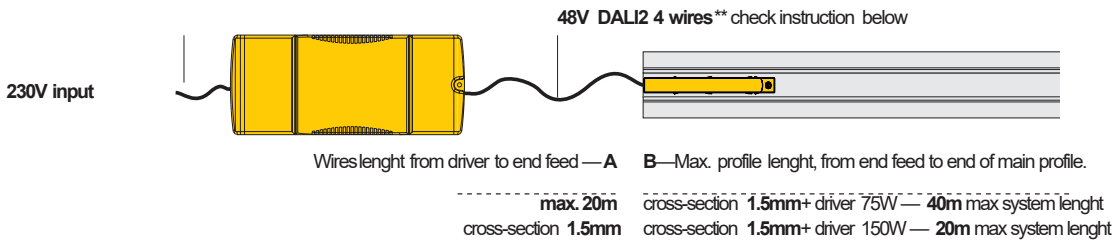
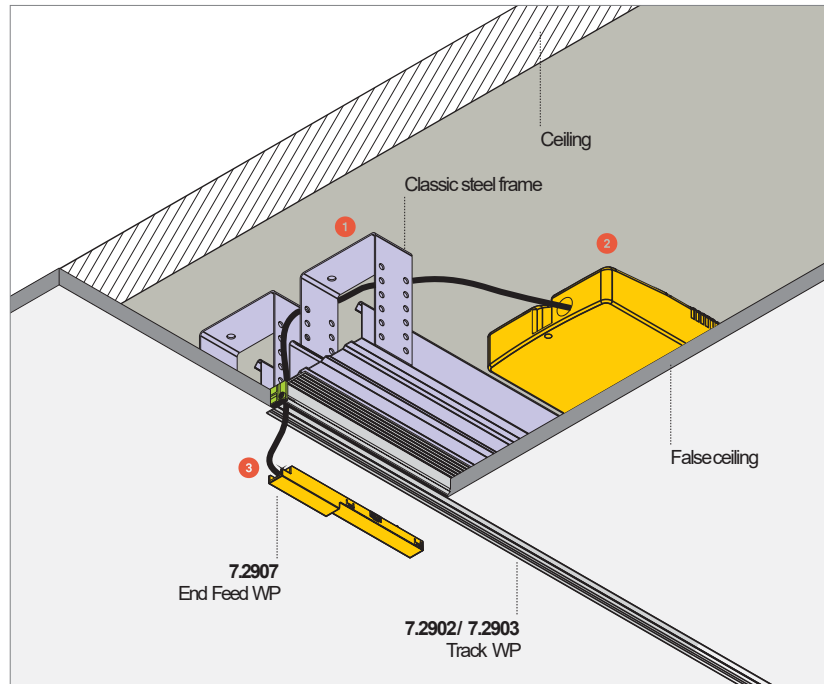

Electric diagram DALI2

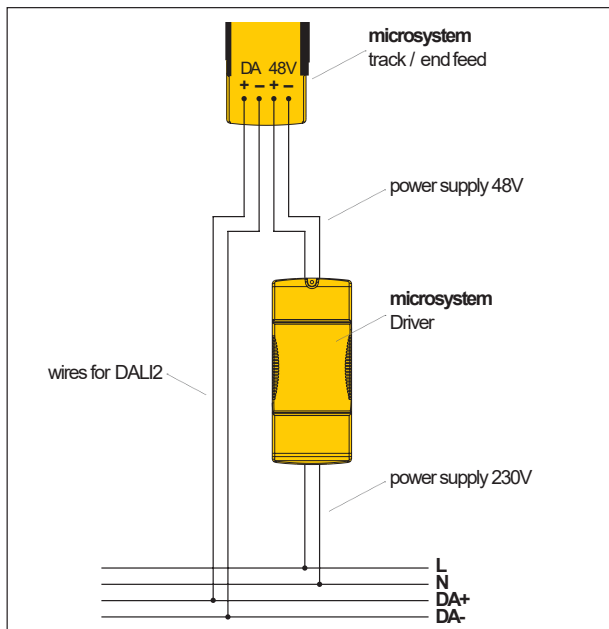

Technical info 48V

Max. working temperature: 70°C
 Ambient temperature: 25°C
 Voltage: 0-60V DC
 Class III, SELV

The system is intended for use ONLY with safe voltage >60V DC. System available only in DALI version, it requires usage of 4 wires (2 for 48V power supply + 2 for DALI control)

Dimming control requires the simultaneous use of one of the 48V power supplies + DALI2 gate and luminaires marked as DALI2 versions - each luminaire can be addressed separately.

Choosing a driver

LABRA recommends using the 48V drivers listed in this catalog, but it is not forbidden to use other 48V power supplies, provided the technical conditions are met.

For trouble-free operation of the system, we recommend that the fittings used do not exceed in total 90% of the power supply used, e.g.

- | | |
|----------------|------------------------------------|
| 1. Driver 75W | Flato 7.4Wx9 szt. = 67W |
| 2. Driver 150W | Shift Micro 3x17.8Wx 17szt. = 133W |

details subject to change.

LABRA

