



ARMZ interior design studio

fol. Andriy Nechayev

texo

texo

Texo – a simple and yet an elegant form of truncated or straight tube available in various mounting and finishing options. The Texo M.60 NT and ZW range offers six different body lengths; the inside of the bodies can be changed with colourful inserts which add character to the minimalist luminaires. A spectacular spatial effect can be achieved by combining Texo pendants of different lengths, mounting them centrally, close together or parallel in a straight line. Such arrangements look great over a dining table or a coffee table in a living room. An important part of the range is represented by Texo Single luminaires – that is simple spotlights for surface-mounting and mounting on the a 1For a 3F rail; the luminaire features a concealed hinge, which enables precise adjustment of its tilt angle.

The family also includes LED versions of XS.50 and XL.75 luminaires with built-in power supplies. The distinctive feature of these models is the recessed optics and the massive ring around it.



texo M.60 single cut / xl.75 ad 3F / xs.50 ad 3F







Model	On-Off	White + Black	White + Gold	White + Orange	Black + White	Black + Gold	Black + Orange	Black	White	Mixed	CR88-2700K	CR88-3000K	CR88-4000K	Spot 21°	Medium 40°	Wide 57°
Texo Single ⊕		.33	.88	.56	.44	.77	.66	.02	.03	.99	.927	.930	.940	.S	.M	.W
1 M.60 NT 1x7WGU10 QPAR16LED	2.1890	•	•	•	•	•	•			•						
2 M.60 AD 1F 1x7WGU10 QPAR16LED	7.1891	•	•	•	•	•	•			•						
3 M.60 AD 3F 1x7WGU10 QPAR16LED	7.1892	•	•	•	•	•	•			•						
Texo Single Cut ⊕																
1 M.60 Cut NT 1x7WGU10 QPAR16LED	2.1887	•	•	•	•	•	•			•						
2 M.60 Cut AD 1F 1x7WGU10 QPAR16LED	7.1888	•	•	•	•	•	•			•						
3 M.60 Cut AD 3F 1x7WGU10 QPAR16LED	7.1889	•	•	•	•	•	•			•						
Texo Move ⊕																
1 NT 1x50WGU10 QPAR16	3.0272							•	•	•						
TexoXS/ XL ⊕																
1 XS.50 LED Reflektor NT 1x10W700lm, 47°	2.2444	•			•			•	•	•	•	•				
2 XS.50 G3NT 1x10W700lm, 47°	3.2768	•			•			•	•	•	•	•				
3 XS.50 G3AD 1F 1x10W700lm, 47°	7.2769	•			•			•	•	•	•	•				
4 XS.50 G3AD 3F 1x10W700lm, 47°	7.2770	•			•			•	•	•	•	•				
5 XL.75 G2NT H115 1x14W1050lm	3.2711	•			•			•	•	•	•	•		•	•	•
6 XL.75 G2NT H150 1x14W1050lm	3.2712	•			•			•	•	•	•	•		•	•	•
7 XL.75 G2H115AD 3F 1x14W1050lm	7.2713	•			•			•	•	•	•	•		•	•	•
8 XL.75 G2H150AD 3F 1x14W1050lm	7.2714	•			•			•	•	•	•	•		•	•	•



Texo M.60 Single

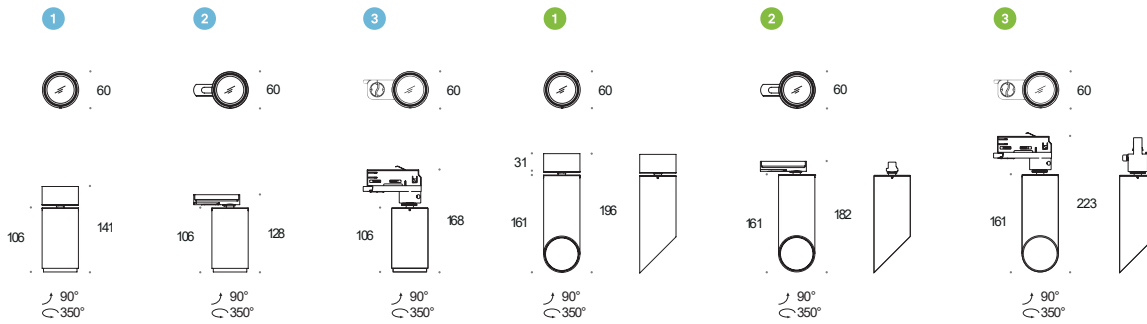

Texo Move

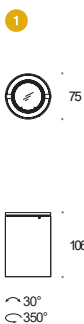

Texo XS.50

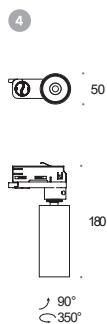
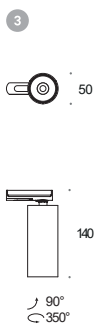
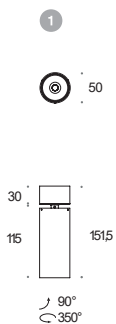

Texo XL.75

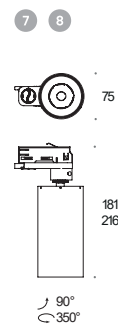
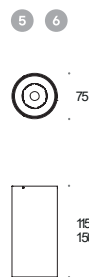

Model	On-Off	Accessories	Color				
			Gold	Miedziany	Black	White	Mixed
TexoM.60 NT ⊕			.08	.40	.02	.03	.99
1 H100 1x7WGU10 QPAR16LED	3.1958				•	•	•
H200 1x7WGU10 QPAR16LED	3.1959				•	•	•
H300 1x7WGU10 QPAR16LED	3.1960				•	•	•
H400 1x7WGU10 QPAR16LED	3.1961				•	•	•
H500 1x7WGU10 QPAR16LED	3.1962				•	•	•
H600 1x7WGU10 QPAR16LED	3.1963				•	•	•
TexoM.60 ZW ⊕							
1 H100 1x7WGU10 QPAR16LED	5.1964				•	•	•
H200 1x7WGU10 QPAR16LED	5.1965				•	•	•
H300 1x7WGU10 QPAR16LED	5.1966				•	•	•
H400 1x7WGU10 QPAR16LED	5.1967				•	•	•
H500 1x7WGU10 QPAR16LED	5.1968				•	•	•
H600 1x7WGU10 QPAR16LED	5.1969				•	•	•
1 M.60 DecoRing [option]	9.1956		•	•	•	•	•
TexoCut M.60 NT ⊕							
1 H160 1x7WGU10 QPAR16LED	3.1970				•	•	•
H260 1x7WGU10 QPAR16LED	3.1971				•	•	•
H360 1x7WGU10 QPAR16LED	3.1972				•	•	•
H460 1x7WGU10 QPAR16LED	3.1973				•	•	•
H560 1x7WGU10 QPAR16LED	3.1974				•	•	•
H660 1x7WGU10 QPAR16LED	3.1975				•	•	•
TexoCut M.60 ZW ⊕							
1 H160 1x7WGU10 QPAR16LED	5.1976				•	•	•
H260 1x7WGU10 QPAR16LED	5.1977				•	•	•
H360 1x7WGU10 QPAR16LED	5.1978				•	•	•
H460 1x7WGU10 QPAR16LED	5.1979				•	•	•
H560 1x7WGU10 QPAR16LED	5.1980				•	•	•
H660 1x7WGU10 QPAR16LED	5.1981				•	•	•
2 M.60 DecoRing [option]	9.1957		•	•	•	•	•

Texo M.60

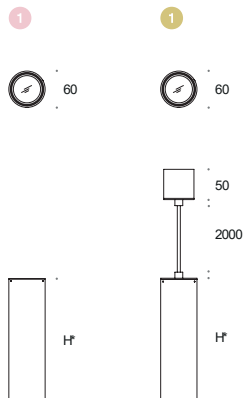

Texo Cut M.60

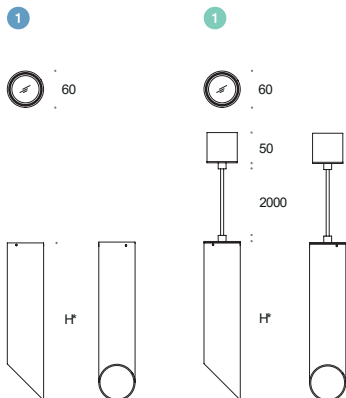

Texo / Texo Cut Deco Ring



details subject to change.